



FLEX800™ SERIES ROTORS





FLEX800™ SERIES GOLF SPRINKLERS

Golf sprinklers with all the efficiency
and proven performance features and
benefits of the 800S and DT Series



TRAJECTORY ADJUSTMENT

In 24-position TruJectory or Dual trajectory to help fight the wind, avoid obstacles or to reduce the radius.



RATCHETING RISER

Align part circle quickly and easily or adjust watering locations to suit seasonal needs.



LARGE NOZZLE SELECTION

From 10,5m to 30,5m (34' to 100') we've got you covered! Only Toro provides the flexibility to optimize your system for maximum uniformity.



PART AND FULL CIRCLE MODELS

Align part circle quickly and easily or adjust watering locations to suit seasonal needs.





FLEX800™ SERIES GOLF ROTORS FLX35-6/FLX55-6



With the industry's largest selection of high performance nozzles and TruJectory adjustment the NEW FLEX800 35-6/55-6 Series allows you to put water precisely where you want it for maximum distribution uniformity. The part/full circle drive allows you to simply and economically adjust the area of coverage to match your seasonal watering needs or meet water rationing mandates in seconds with no disassembly or additional parts required. Finally, with TruJectory you have 24 positions from 7 to 30° in 1° increments to put water where you want it.

Features & Benefits

TruJectory - 24 positions

From 7° - 30° in 1° increments put water where you want it. Adjust from the top of the sprinkler in seconds, wet or dry. This flexibility lets you tackle every obstacle on the course; wind, trees, bunkers, mounds and more.

Industries Largest Nozzle Selection

Nozzles from 12,8m – 30,5m (42' to 100') radius plus a wide assortment of back nozzles lets you put the precise amount of water exactly where you need it. All nozzles threaded in from the front.

Ratcheting Riser

Align part circle quickly and easily or adjust watering locations to suit seasonal needs.

True Part and Full-Circle in One – (40° - 330° part circle)

These sprinklers can be full circle today and part circle tomorrow allowing you to simply and economically adjust the area of coverage to match your seasonal needs or meet water rationing mandates.





FLX35-6 Conversion Upgrades

Models	Description
• FLX35-6-3134	FLX35-6 w/31-34 Nozzles (33 Nozzle Installed)
• FLX35-6-3537	FLX35-6 w/35-37 Nozzles (35 Nozzle Installed)



FLX55-6 Conversion Upgrades—(Ribbed Body)

Models	Description
• FLX55-6-5154	FLX55-6 w/51-54 Nozzles (53 Nozzle Installed)
• FLX55-6-5558	FLX55-6 w/55-58 Nozzles (55 Nozzle Installed)
• FLX55-6-59	FLX55-6 w/59 Nozzle



FLX55-6 Conversion Upgrades—(Ribless Body)

Models	Description
• FLX55-6-5154R	FLX55-6 w/51-54 Nozzles (53 Nozzle Installed)
• FLX55-6-5558R	FLX55-6 w/55-58 Nozzles (55 Nozzle Installed)
• FLX55-6-59R	FLX55-6 w/59 Nozzle



Features

- Trajectory: 24 positions from 7° – 30° in 1° increments
- Part/Full circle sprinklers
- Pop-up height to nozzle: 8,25cm (3.25")

Operating Specifications

Inlet:

- FLX35-6: 25mm (1") ACME
- FLX55-6: 40mm (1.5") ACME

Radius:

- FLX35-6: 12,8 – 28,0m (42' – 92')
- FLX55-6: 15,9 – 30,5m (52' – 100')

Flow Rate:

- FLX35-6: 26,9-171,5 LPM (7.1 – 45.3 GPM)
- FLX55-6: 52,6-231,3 LPM (13.9 – 61.1 GPM)

Precipitation Rates:

- FLX35-6: Minimum: 9mm/hr (0.37"/hr);
Maximum: 13,5mm/hr (0.53"/hr)
- FLX55-6: Minimum: 11mm/hr (0.43"/hr);
Maximum: 15mm/hr (0.60"/hr)

Pilot Valve: Selectable at 3,4; 4,5; 5,5; and 6,9 Bar (50, 65, 80 and 100 psi)

Recommended Operating Pressure Range:

- 4,5-6,9 Bar (65-100 psi)
- Maximum: 10,3 Bar (150 psi)
- Minimum: 2,8 Bar (40 psi)

Activation types – Electric Valve-in-Head:

- Standard Solenoid:
 - 24 VAC, 50/60 Hz
 - Inrush: 0.30 A
 - Holding 0.20 A
- Spike Guard Solenoid:
 - 24 VAC, 50/60 Hz
 - Inrush: 0.12 A
 - Holding 0.10 A
- Nickel-Plated Spike Guard Solenoid:
 - 24 VAC, 50/60 Hz
 - Inrush: 0.12 A
 - Holding 0.10 A
- DC Latching Solenoid (DCLS):
 - 12 VDC pulse or latching pulse
- Integrated GDC Module w/DCLS:
 - 12 VDC pulse or latching pulse

Nozzle Selection

- FLX35-6 has eight nozzle variation (30, 31, 32, 33, 34, 35, 36 & 37)
- FLX55-6 has nine nozzle variations (51, 52, 53, 54, 55, 56, 57, 58 & 59)
- Four in-line nozzles, rotating stream pattern
- One back nozzle position

Dimensions

- Body diameter:
 - FLX35-6: 16,5cm (6.5")
 - FLX55-6: 19cm (7.5")
- Body height:
 - FLX35-6: 25cm (10")
 - FLX55-6: 29cm (11.38")
- Weight:
 - FLX35-6: 1,35kg (2.98 lbs.)
 - FLX55-6: 1,68kg (3.70 lbs.)

Warranty

- Two years; Five years when installed with Toro Swing Joints

Specifying Information—FLX35-6 & FLX55-6

FLXX5-XXX-X6					
Body Inlet	Arc	Nozzle	Pressure Regulation*	Activation Type	Trajectory
FLXX	X	XX	X	X	
3— 25mm (1") 5— 40mm (1.5")	5—Part-circle and Full-circle In One	FLX35 - 30 31 32 33 34 35 36 37 FLX55 - 51 52 53 54 55 56 57 58 59	6— 4,5 bar (65 psi) 8— 6,5 bar (80 psi) 1— 6,9 bar (100 psi)	1—Standard Solenoid 2—Spike Guard™ Solenoid 3—Nickel-plated Spike Guard Solenoid 4—DC Latching Solenoid (DCLS) 5—Integrated GDC Module w/DCLS	6—24-position Trajectory
Example: When specifying an FLX35-6 Series Sprinkler with Spike Guard™ Solenoid, #34 nozzle, an electric valve and pressure regulation at 4,5 bar (65 psi) you would specify: FLX35-346-26					

* Electric models only. All sprinklers are equipped with the selectable pilot valve that allows settings at 3,4; 4,5; 5,5; and 6,9 Bar (50, 65, 80 and 100 psi).
Note: Not all models available. Nickel-plated, corrosion-resistant models are available upon request.



FLEX800™ SERIES GOLF ROTORS FLX35-6/FLX55-6

FLX35-6/FLX55-6 Trajectory Performance—(Metric)

Nozzle/Bar/LPM	#31/51 Nozzle @ 4,5 Bar												#32/52 Nozzle @ 4,5 Bar											
	Trajectory		7°	10°	15°	20°	25°	30°	7°		10°	15°	20°	25°	30°									
"A" Radius	14,0		14,0	15,2	15,5	16,2	16,5	15,2	14,0	14,9	14,9	15,2	15,5	16,8	19,2	19,5	16,5	19,8						
"B" Spray Height	1,2		1,2	1,5	1,8	2,4	3,0	3,4	4,0	4,0	4,6	0,9	1,2	1,2	1,8	2,7	3,7	3,4	4,6	4,0				
"C" Distance from Head	7,6	7,9	7,6	8,2	7,9	9,8	10,1	11,6	10,1	12,2	10,1	12,4	6,1	6,7	7,3	7,9	8,5	9,4	10,4	10,7	10,4	9,1		

Nozzle/Bar/LPM	#33/53 Nozzle @ 4,5 Bar												#34/54 Nozzle @ 4,5 Bar											
	Trajectory		7°	10°	15°	20°	25°	30°	7°		10°	15°	20°	25°	30°									
"A" Radius	16,5		17,1	18,0	18,9	20,1	20,7	18,6	17,7	18,3	19,2	20,4	22,6	21,3										
"B" Spray Height	1,2		1,5	1,5	1,8	2,1	2,7	4,0	4,6	1,2	1,5	1,2	1,8	1,8	2,4	3,4	3,0	4,3	5,2					
"C" Distance from Head	7,0	9,1	8,5	10,1	9,8	10,4	10,7	10,7	11,3	10,7	11,3	7,3	9,4	7,9	10,4	10,7	12,2	11,9	12,5	11,9	11,9	12,8		

Nozzle/Bar/LPM	#35/55 Nozzle @ 4,5 Bar												#36/56 Nozzle @ 5,5 Bar											
	Trajectory		7°	10°	15°	20°	25°	30°	7°		10°	15°	20°	25°	30°									
"A" Radius	18,0		18,6	18,9	19,5	20,1	21,3	23,2	22,6	23,5	19,5	21,9	20,7	22,2	23,2	22,9	24,4	25,0	25,6	25,9	25,0			
"B" Spray Height	1,2		1,8	1,5	1,8	2,1	2,7	3,4	4,6	5,2	1,5	2,1	2,7	4,3	5,2	6,7								
"C" Distance from Head	9,1	10,4	9,8	11,0	11,0	13,1	13,1	13,7	13,1	13,7	13,1	13,7	7,6	11,6	12,2	13,7	14,9	13,7						

Nozzle/Bar/LPM	#37/57 Nozzle @ 5,5 Bar												#58 Nozzle @ 5,5 Bar											
	Trajectory		7°	10°	15°	20°	25°	30°	7°		10°	15°	20°	25°	30°									
"A" Radius	19,8		21,9	21,0	22,6	23,8	23,5	25,0	25,3	26,2	27,1	25,6	25,9	22,9	23,5	25,3	26,5	28,0	26,8					
"B" Spray Height	1,5		2,1	2,1	2,7	4,3	5,5	6,7	1,8	2,1	3,0	4,6	5,5	6,7										
"C" Distance from Head	9,1	11,9	11,9	12,5	12,5	14,0	15,2	14,0	11,6	12,2	13,1	14,3	15,8	14,6										

Nozzle/Bar/LPM	#59 Nozzle @ 5,5 Bar											
	Trajectory		7°	10°	15°	20°	25°	30°				
"A" Radius	23,5		23,8	25,6	27,1	29,3	28,0					
"B" Spray Height	2,1		2,4	3,4	4,9	6,4	7,6					
"C" Distance from Head	12,8	13,4	13,7	14,3	16,2	14,9						

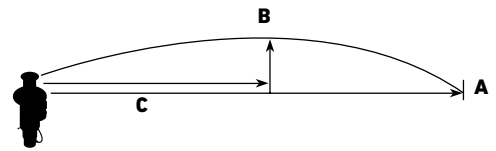

Information is for reference only, Actual results may vary.

FLX35-6 Series Performance Chart—(Metric)

Base Pressure	Nozzle Set 30		Nozzle Set 31		Nozzle Set 32		Nozzle Set 33		Nozzle Set 34		Nozzle Set 35		Nozzle Set 36		Nozzle Set 37	
	(White) 102-2208		(Yellow) 102-4587		(Blue) 102-4588		(Brown) 102-4589		(Orange) 102-0728		(Green) 102-0729		(Gray) 102-0730		(Black) 102-4261	
	Blue	Gray	Blue	Gray	Red	Gray	Orange	Gray	Orange	Gray	Blue	Gray	Blue	Gray	Orange	Gray
Bar	kPa	kg/cm ²	Radius	LPM	Radius	LPM	Radius	LPM	Radius	LPM	Radius	LPM	Radius	LPM	Radius	LPM
3,4	340	3,47	12,8	26,9	15,9	51,9	18,6	64,7	19,5	76,5	21,0	103,7	—	—	—	—
4,5	450	4,59	13,7	32,9	16,5	58,7	19,2	77,6	20,1	86,7	22,6	113,6	23,2	122,6	—	—
5,5	550	5,61	14,0	36,3	17,4	64,3	20,4	85,5	21,4	95,8	23,5	125,7	24,1	135,5	25,6	141,9
6,9	690	7,04	14,6	42,4	18,0	71,5	22,0	95,4	22,6	106,7	24,4	140,0	25,6	151,0	26,8	160,9
Stator			102-6929 Blue				102-1939 Yellow				102-1940 White					
Conversions			FLX35-6-3134												FLX35-6-3537	

FLX55-6 Series Performance Chart—(Metric)

Base Pressure	Nozzle Set 51		Nozzle Set 52		Nozzle Set 53		Nozzle Set 54		Nozzle Set 55		Nozzle Set 56		Nozzle Set 57		Nozzle Set 58		Nozzle Set 59	
	(Yellow) 102-4587		(Blue) 102-4588		(Brown) 102-4589		(Orange) 102-0728		(Green) 102-0729		(Gray) 102-0730		(Black) 102-4261		(Red) 102-4260		(Beige) 102-4259	
	Blue	Gray	Red	Gray	Orange	Gray	Orange	Gray	Blue	Gray	Blue	Gray	Orange	Gray	Blue	Gray	Blue	Gray
Bar	kPa	kg/cm ²	Radius	LPM	Radius	LPM	Radius	LPM	Radius	LPM	Radius	LPM	Radius	LPM	Radius	LPM	Radius	LPM
3,4	340	3,47	15,9	52,6	18,9	65,9	20,1	78,3	21,0	108,3	—	—	—	—	—	—	—	
4,5	450	4,59	16,5	59,4	19,5	78,3	20,7	88,6	22,6	113,1	23,2	127,9	—	—	—	—	—	
5,5	550	5,61	17,4	65,1	20,7	86,7	22,0	97,7	23,5	130,2	24,1	140,8	25,9	149,1	27,1	165,0	28,1	179,8
6,9	690	7,04	18,0	72,3	22,3	96,5	23,2	108,6	24,4	144,6	25,6	156,3	27,1	165,4	28,7	183,6	29,0	194,9
Stator			102-1939 Yellow				102-1940 White				102-1941							
Conversions			FLX55-6-5154												FLX55-6-5558		FLX55-6-59	

Not recommended at these pressures. Radius shown in meters. Toro recommends the use of a 30mm swing joint at flows over 95-LPM. Sprinkler radius of throw per ASAE standard S398.1. Actual site conditions must be considered when selecting the appropriate nozzle. All sprinklers are equipped with the selectable pilot valve that allows settings at 3,4; 4,5; 5,5; and 6,9 Bar.



FLX35-6/FLX55-6 Trajectory Performance—(U.S.)

Nozzle/PSI/GPM	#31/51 Nozzle @ 65 psi						#32/52 Nozzle @ 65 psi					
	7°	10°	15°	20°	25°	30°	7°	10°	15°	20°	25°	30°
Trajectory	7°	10°	15°	20°	25°	30°	7°	10°	15°	20°	25°	30°
"A" Radius	46'	46'	50'/51'	53'	54'	50'	46'/49'	49'/50'	51'	55'	63'/64'	54'/65'
"B" Spray Height	4'	4'	5'/6'	8'/10'	11'/13'	13'/15'	3'/4'	4'	6'	9'	12'/11'	15'/13'
"C" Distance from Head	25'/26'	25'/27'	26'/32'	33'/38'	33'/40'	33'/41'	20'/22'	24'/26'	28'/31'	34'/35'	34'	34'/30'

Nozzle/PSI/GPM	#33/53 Nozzle @ 65 psi						#34/54 Nozzle @ 65 psi					
	7°	10°	15°	20°	25°	30°	7°	10°	15°	20°	25°	30°
Trajectory	7°	10°	15°	20°	25°	30°	7°	10°	15°	20°	25°	30°
"A" Radius	54'	56'	59'	62'	66'/68'	61'	58'	60'	63'	67'	74'	70'
"B" Spray Height	4'/5'	5'/6'	7'	9'	13'	15'	4'/5'	4'/6'	6'/8'	11'/10'	14'	17'
"C" Distance from Head	23'/30'	28'/33'	32'	34'/35'	35'/37'	35'/37'	24'/31'	26'/34'	35'/40'	39'/41'	39'	39'/42'

Nozzle/PSI/GPM	#35/55 Nozzle @ 65 psi						#36/56 Nozzle @ 80 psi					
	7°	10°	15°	20°	25°	30°	7°	10°	15°	20°	25°	30°
Trajectory	7°	10°	15°	20°	25°	30°	7°	10°	15°	20°	25°	30°
"A" Radius	59'	61'/62'	64'/66'	70'	76'	74'/77'	64'/72'	68'/73'	76'/75'	80'/82'	84'/85'	82'
"B" Spray Height	4'/6'	5'/6'	7'/9'	11'	15'	17'	5'	7'	9'	14'	17'	22'
"C" Distance from Head	30'/34'	32'/36'	36'/43'	43'/45'	43'/45'	43'/45'	25'	38'	40'	45'	49'	45'

Nozzle/PSI/GPM	#37/57 Nozzle @ 80 psi						#58 Nozzle @ 80 psi					
	7°	10°	15°	20°	25°	30°	7°	10°	15°	20°	25°	30°
Trajectory	7°	10°	15°	20°	25°	30°	7°	10°	15°	20°	25°	30°
"A" Radius	65'/72'	69'/74'	78'/77'	82'/83'	86'/89'	84'/85'	75'	77'	83'	87'	92'	88'
"B" Spray Height	5'	7'	9'	14'	18'	22'	6'	7'	10'	15'	18'	22'
"C" Distance from Head	30'	39'	41'	46'	50'	46'	38'	40'	43'	47'	52'	48'

Nozzle/PSI/GPM	#59 Nozzle @ 80 psi					
	7°	10°	15°	20°	25°	30°
Trajectory	7°	10°	15°	20°	25°	30°
"A" Radius	77'	78'	84'	89'	96'	92'
"B" Spray Height	7'	8'	11'	16'	21'	25'
"C" Distance from Head	42'	44'	45'	47'	53'	49'

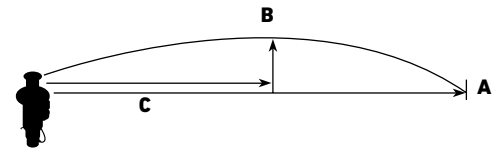

Information is for reference only. Actual results may vary.

FLX35-6 Series Performance Chart—(U.S.)

Base Pressure	Nozzle Set 30 (White) 102-2208		Nozzle Set 31 (Yellow) 102-4587		Nozzle Set 32 (Blue) 102-4588		Nozzle Set 33 (Brown) 102-4589		Nozzle Set 34 (Orange) 102-0728		Nozzle Set 35 (Green) 102-0729		Nozzle Set 36 (Gray) 102-0730		Nozzle Set 37 (Black) 102-4261	
	Blue	Gray	Blue	Gray	Red	Gray	Orange	Gray	Orange	Gray	Blue	Gray	Blue	Gray	Orange	Gray
	102-2925	102-2910	102-2925	102-2910	102-2928	102-2910	102-2926	102-2910	102-2926	102-2910	102-2925	102-2910	102-2925	102-2910	102-2926	102-2910
psi	Radius	GPM	Radius	GPM	Radius	GPM	Radius	GPM	Radius	GPM	Radius	GPM	Radius	GPM	Radius	GPM
50	42	7.1	52	13.7	61	17.1	64	20.2	69	27.4	—	—	—	—	—	—
65	45	8.7	54	15.5	63	20.5	66	22.9	74	30.0	76	32.4	—	—	—	—
80	46	9.6	57	17.0	67	22.6	70	25.3	77	33.2	79	35.8	84	37.5	86	40.8
100	48	11.2	59	18.9	72	25.2	74	28.2	80	37.0	84	39.9	88	42.5	92	45.3
Stator	102-6929 Blue				102-1939 Yellow								102-1940 White			
Conversions					FLX35-6-3134								FLX35-6-3537			

FLX55-6 Series Performance Chart—(U.S.)

Base Pressure	Nozzle Set 51 (Yellow) 102-4587		Nozzle Set 52 (Blue) 102-4588		Nozzle Set 53 (Brown) 102-4589		Nozzle Set 54 (Orange) 102-0728		Nozzle Set 55 (Green) 102-0729		Nozzle Set 56 (Gray) 102-0730		Nozzle Set 57 (Black) 102-4261		Nozzle Set 58 (Red) 102-4260		Nozzle Set 59 (Beige) 102-4259	
	Blue	Gray	Red	Gray	Orange	Gray	Orange	Gray	Blue	Gray	Blue	Gray	Orange	Gray	Blue	Gray	Blue	Gray
	102-2925	102-2910	102-2928	102-2910	102-2926	102-2910	102-2926	102-2910	102-2925	102-2910	102-2925	102-2910	102-2926	102-2910	102-2925	102-2910	102-2925	102-2910
psi	Radius	GPM	Radius	GPM	Radius	GPM	Radius	GPM	Radius	GPM	Radius	GPM	Radius	GPM	Radius	GPM	Radius	GPM
50	52	13.9	62	17.4	66	20.7	69	28.6	—	—	—	—	—	—	—	—	—	—
65	54	15.7	64	20.8	68	23.4	74	31.2	76	33.8	—	—	—	—	—	—	—	—
80	57	17.2	68	22.9	72	25.8	77	34.4	79	37.2	85	39.4	89	43.6	92	47.5	96	57.0
100	59	19.1	73	25.5	76	28.7	80	38.2	84	41.3	89	43.7	94	48.5	95	51.1	100	61.1
Stator	102-1939 Yellow								102-1940 White									
Conversions	FLX55-6-5154								FLX55-6-5558									

Toro recommends the use of a 1.25" swing joint at flows over 25-GPM (95-LPM). Sprinkler radius data collected in Toro's zero wind test facility per ASAE standard S398.1. Actual site conditions must be considered when selecting the appropriate nozzle. All sprinklers are equipped with the selectable pilot valve that allows settings at 50, 65, 80 and 100 psi.



FLEX800™ SERIES GOLF ROTORS FLX35/FLX55

The New FLEX800 35/55 Series features a dual trajectory main nozzle that provides exceptional nozzle performance at the 25° standard angle position and great performance in windy applications at the 15° low angle position. And the part/full circle drive allows you to adjust the area of coverage to match your seasonal watering needs or meet water rationing mandates in seconds with no additional parts required.

Features & Benefits

Dual Trajectory 25° or 15°

The 25° setting provides maximum distance of throw and the 15° setting provides improved wind performance, radius reduction and obstacle avoidance.

Industries Largest Nozzle Selection

Nozzles from 13,1m - 28,0m (43' to 92') radius plus a wide assortment of back nozzles lets you put the precise amount of water exactly where you need it. All nozzles threaded in from front.

Ratcheting riser

Toro exclusive, simply pull up the riser and ratchet it to the precise position you want to water.

Radius Reduction Screw

Allows for fine tuning the radius to exactly the distance you need. In combination with main nozzle sizing and trajectory adjustment the radius reduction screw (363-4839) can effectively reduce the sprinkler throw down to 9,1m (30').

True Part and Full-Circle in One – (40° - 330° part circle)

These sprinklers can be full circle today and part circle tomorrow allowing you to adjust the area of coverage to match your seasonal needs or meet water rationing mandates.

9



FLX35

FLX55

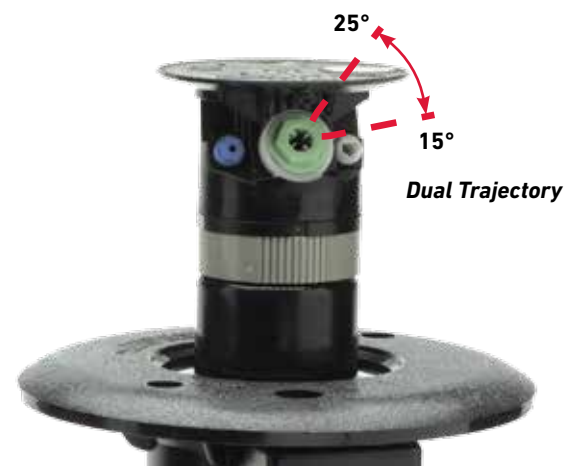



FLX35 Conversion Upgrades

Models	Description
• FLX35-3134	FLX35 w/31–34 Nozzles (#3 Nozzle)
• FLX35-3537	FLX35 w/35–37 Nozzles (#5 Nozzle)



FLX55 Conversion Upgrades (Ribbed Body)

Models	Description
• FLX55-5154	FLX55 w/51–54 Nozzles (#3 Nozzle)
• FLX55-5558	FLX55 w/55–58 Nozzles (#5 Nozzle)
• FLX55-59	FLX55 w/59 Nozzle



FLX55 Conversion Upgrades (Ribless Body)

Models	Description
• FLX55-5154R	FLX55 w/51–54 Nozzles (#3 Nozzle)
• FLX55-5558R	FLX55 w/55–58 Nozzles (#5 Nozzle)
• FLX55-59R	FLX55 w/59 Nozzle



Features

- Dual Trajectory adjustment on main nozzle - 25° or 15°
- Part/Full circle sprinklers
- Radius reduction screw 363-4839 for fine tuning
- Ratcheting riser
- Nozzle base clutching
- Pop-up height to nozzle: 8,25cm (3.25")

Operating Specifications

Inlet:

- FLX35: 25mm (1") ACME
- FLX55: 40mm (1.5") ACME

Radius:

- FLX35: 13,1 – 25,3m (43' – 83')
- FLX55: 16,7 – 28,0m (55' – 92')

Flow Rate:

- FLX35: 31,0 – 179,0 LPM (8.2 – 47.8 GPM)
- FLX55: 53,0 – 232,0 LPM (14.1 – 61.3 GPM)

Precipitation Rates:

- FLX35: Minimum: 10,4 mm/hr (0.41"/hr); Maximum: 11,4 mm/hr (0.45"/hr)
- FLX55: Minimum: 11,7 mm/hr (0.46"/hr); Maximum: 14,7 mm/hr (0.58"/hr)

Pilot Valve:

- Selectable at 3,4; 4,5; 5,5; and 6,9 Bar (50, 65, 80, 100 psi)

Recommended Operating Pressure Range:

- 4,5-6,9 Bar (65-100 psi)
- Maximum: 10,3 Bar (150 psi)
- Minimum: 2,8 Bar (40 psi)

Activation types – Electric Valve-in-Head:

- Standard Solenoid:

- 24 VAC, 50/60 Hz
- Inrush: 0.30 A
- Holding 0.20 A

- Spike Guard Solenoid:

- 24 VAC, 50/60 Hz
- Inrush: 0.12 A
- Holding 0.10 A

- Nickel-Plated Spike Guard Solenoid:

- 24 VAC, 50/60 Hz
- Inrush: 0.12 A
- Holding 0.10 A

- DC Latching Solenoid (DCLS):

- 12 VDC pulse or latching pulse

- Integrated GDC Module w/DCLS:

- 12 VDC pulse or latching pulse

Nozzle Selection

- FLX35 has eight nozzle variations (30, 31, 32, 33, 34, 35, 36 & 37)
- FLX55 has nine nozzle variations (51, 52, 53, 54, 55, 56, 57, 58 & 59)
- Three in-line nozzles, rotating stream pattern
- Two back nozzle positions

Dimensions

- Body diameter:
 - FLX35-6: 16,5cm (6.5")
 - FLX55-6: 19cm (7.5")
- Body height:
 - FLX35: 25cm (10")
 - FLX55: 29cm (11.38")
- Weight:
 - FLX35-6: 1,31kg (2.89 lbs.)
 - FLX55-6: 1,62kg (3.57 lbs.)
- Weight-Integrated GDC
 - FLX35: 1,62kg (3.57 lbs.)
 - FLX55: 1,93kg (4.26 lbs.)

Warranty

- Two years; Five years when installed with Toro Swing Joints

Specifying Information—FLX35 & FLX55

FLXX5-XXX-X				
Body Inlet	Arc	Nozzle	Pressure Regulation*	Activation Type
FLXX	5	XX	X	X
3—25mm (1") 5—40mm (1½")	5—Part-circle and Full-circle In One	FLX35—30, 31, 32, 33, 34, 35, 36, 37 FLX55—51, 52, 53, 54, 55, 56, 57, 58, 59	6— 4,5 bar (65 psi) 8— 6,5 bar (80 psi) 1— 6,9 bar (100 psi)	1—Standard Solenoid 2—Spike Guard™ Solenoid 3—Nickel-plated Spike Guard Solenoid 4—DC Latching Solenoid (DCLS) 5—Integrated GDC Module w/DCLS

Example: When specifying an FLX35 Series Sprinkler with #34 nozzle, pressure regulation at 4,5 bar (65 psi) and Spike Guard you would specify: FLX35-346-2

* All sprinklers are equipped with the selectable pilot valve that allows settings at 3,4; 4,5; 5,5; and 6,9 Bar (50, 65, 80 and 100 psi).
Note: Not all models available. Nickel-plated, corrosion-resistant models are available upon request.



FLX800™ SERIES GOLF ROTORS FLX35/FLX55

FLX35 Performance Data—25° – (Metric)

Front Nozzle Positions		Nozzle Set 30		Nozzle Set 31		Nozzle Set 32		Nozzle Set 33		Nozzle Set 34		Nozzle Set 35		Nozzle Set 36		Nozzle Set 37				
		(White Plug)		(Yellow)		(Blue)		(Brown)		(Orange)		(Green)		(Gray)		(Black)				
		102-2208		102-6906		102-0726		102-6907		102-0728		102-6955		102-6935		102-6936				
		102-5670	102-6942	102-5670	102-5671	102-5670	102-6884	102-5670	102-6884	102-5670	102-6884	102-5670	102-6885	102-6531	102-6885	102-6531	102-6885			
Back Nozzle Positions		 Red Plug 102-4335																		
Bar	kPa	kg/cm2	Radius	LPM	Radius	LPM	Radius	LPM	Radius	LPM	Radius	LPM	Radius	LPM	Radius	LPM	Radius	LPM		
3,4	340	3,47	13,1	31,0	16,2	52,2	17,1	69,3	18,6	82,1	—	—	—	—	—	—	—	—		
4,5	450	4,59	13,7	37,9	16,2	58,7	18,0	77,6	19,5	92,4	20,7	106,7	22,0	129,1	—	—	—	—		
5,5	550	5,61	14,0	43,5	17,4	65,5	18,9	85,9	20,4	102,6	21,7	117,7	22,9	143,1	23,8	152,5	24,4	166,5		
6,9	690	7,04	14,3	50,7	18,0	72,3	19,8	94,2	21,4	112,8	22,6	129,1	24,1	154,8	24,7	165,8	25,3	179,0		
Stator			102-6929 Blue						102-1939 Yellow						102-1940 White					
Conversions			FLX35-3134												FLX35-3537					

FLX35 Series Performance Chart—15°

Bar	kPa	kg/cm2	Radius	LPM	Radius	LPM	Radius	LPM	Radius	LPM	Radius	LPM	Radius	LPM	Radius	LPM	Radius	LPM		
3,4	340	3,47	13,1	31,0	15,9	51,5	17,7	68,5	18,6	81,4	—	—	—	—	—	—	—			
4,5	450	4,59	13,7	37,9	16,5	57,9	18,3	76,8	19,5	91,6	19,8	103,3	21,0	125,3	—	—	—			
5,5	550	5,61	14,0	43,5	17,7	65,1	19,5	85,5	21,0	101,4	21,0	114,3	22,9	139,3	23,2	150,3	23,2	162,4		
6,9	690	7,04	14,3	50,7	18,3	71,9	20,1	93,5	21,7	111,7	22,0	124,5	23,8	149,5	25,0	161,2	25,0	174,5		
Stator			102-6929 Blue						102-1939 Yellow						102-1940 White					
Conversions			FLX35-3134												FLX35-3537					

FLX55 Performance Data—25° – (Metric)

Front Nozzle Positions		Nozzle Set 51		Nozzle Set 52		Nozzle Set 53		Nozzle Set 54		Nozzle Set 55		Nozzle Set 56		Nozzle Set 57		Nozzle Set 58		Nozzle Set 59				
		(Yellow)		(Blue)		(Brown)		(Orange)		(Green)		(Gray)		(Black)		(Red)		(Beige)				
		102-6906		102-0726		102-6907		102-0728		102-6955		102-6935		102-6936		102-6909		102-4259				
		102-5670	102-5671	102-5670	102-6884	102-5670	102-6884	102-5670	102-6884	102-5670	102-6885	102-6531	102-6885	102-6531	102-6885	102-6531	102-6885	102-6531	102-6885			
Back Nozzle Positions		 Red Plug 102-4335																				
Bar	kPa	kg/cm2	Radius	LPM	Radius	LPM	Radius	LPM	Radius	LPM	Radius	LPM	Radius	LPM	Radius	LPM	Radius	LPM				
3,4	340	3,47	16,7	53,4	17,3	70,0	18,9	84,4	20,1	97,6	—	—	—	—	—	—	—	—				
4,5	450	4,59	17,4	59,8	18,2	79,1	19,8	95,0	21,0	108,6	22,3	135,8	—	—	—	—	—	—				
5,5	550	5,61	18,0	66,2	18,5	87,4	20,7	105,2	21,9	119,9	23,1	150,3	24,4	163,2	25,2	182,5	25,9	189,3				
6,9	690	7,04	18,6	73	19,2	95,7	21,7	114,7	22,8	130,6	24,4	164,6	25,2	185,5	26,8	194,9	27,4	204,0				
Stator			102-1939 Yellow						102-1940 White						102-1941 White							
Conversions			FLX55-5154												FLX55-5558						FLX55-59	

FLX55 Series Performance Chart—15°

Bar	kPa	kg/cm2	Radius	LPM	Radius	LPM	Radius	LPM	Radius	LPM	Radius	LPM	Radius	LPM	Radius	LPM	Radius	LPM				
3,4	340	3,47	16,7	53,0	17,9	62,5	18,9	84,0	19,2	96,9	—	—	—	—	—	—	—					
4,5	450	4,59	17,1	59,0	18,8	78,3	19,8	94,6	20,1	107,9	22,8	133,6	—	—	—	—	—					
5,5	550	5,61	18,0	65,9	20,1	87,1	21,0	104,8	21,4	119,2	23,1	147,6	23,7	160,5	24,0	177,5	24,0	187,4				
6,9	690	7,04	18,2	72,7	20,7	95,0	21,7	114,3	22,0	129,8	24,4	158,6	24,6	184,3	25,3	192,2	25,3	202,1				
Stator			102-1939 Yellow						102-1940 White						102-1941 White							
Conversions			FLX55-5154												FLX55-5558						FLX55-59	

■ Not recommended at these pressures. Radius shown in meters.
 Toro recommends the use of a 30mm swing joint at flows over 95-LPM. Sprinkler radius of throw per ASAE standard S398.1.
 All sprinklers are equipped with the selectable pilot valve that allows settings at 3,4; 4,5; 5,5; and 6,9 Bar.

FLX35 Nozzle Apex—(Metric)

























Pressure	Nozzle	Apex at 15°	Apex at 25°
4,5 bar	31	1,8m @ 15,5m	4m @ 16,4m
	32	1,8m @ 15,5m	3,4m @ 19,5m
	33	2,1m @ 18m	4m @ 20,7m
	34	2,4m @ 19m	4,6m @ 22,6m
	35	2,7m @ 20m	4,6m @ 23m
5,5 bar	36	2,4m @ 22,9m	5,5m @ 25,3m
	37	2,7m @ 22,5m	5,8m @ 25m

FLX55 Nozzle Apex—(Metric)

Pressure	Nozzle	Apex at 15°	Apex at 25°
4,5 bar	51	1,8m @ 15,5m	4m @ 16,4m
	52	1,8m @ 15,5m	3,4m @ 19,5m
	53	2,1m @ 18m	4m @ 20,7m
	54	2,4m @ 19m	4,6m @ 22,6m
	55	2,7m @ 20m	4,6m @ 23m
5,5 bar	56	2,4m @ 22,9m	5,5m @ 25,3m
	57	2,7m @ 22,5m	5,8m @ 25m
	58	3m @ 25m	5,5m @ 26,5m
	59	3,4m @ 24,6m	6,4m @ 27,7m































FLX35 Performance Data—25° – (U.S.)

Front Nozzle Positions	Nozzle Set 30  (White Plug)		Nozzle Set 31  (Yellow)		Nozzle Set 32  (Blue)		Nozzle Set 33  (Brown)		Nozzle Set 34  (Orange)		Nozzle Set 35  (Green)		Nozzle Set 36  (Gray)		Nozzle Set 37  (Black)			
	102-2208		102-6906		102-0726		102-6907		102-0728		102-6955		102-6935		102-6936			
																		
	102-5670	102-6942	102-5670	102-5671	102-5670	102-6884	102-5670	102-6884	102-5670	102-6884	102-5670	102-6885	102-6531	102-6885	102-6531	102-6885		
Back Nozzle Positions	 Red Plug 102-4335																	
PSI	Radius	GPM	Radius	GPM	Radius	GPM	Radius	GPM	Radius	GPM	Radius	GPM	Radius	GPM	Radius	GPM	Radius	GPM
50	43	8.2	53	13.8	56	18.3	61	21.7	65	25.3	—	—	—	—	—	—	—	—
65	45	10.0	53	15.5	59	20.5	64	24.4	68	28.2	72	34.1	—	—	—	—	—	—
80	46	11.5	57	17.3	62	22.7	67	27.1	71	31.1	75	37.8	78	40.3	80	44.0	83	47.3
100	47	13.4	59	19.1	65	24.9	70	29.8	74	34.1	79	40.9	81	43.8	83	47.3	83	47.3

FLX35 Series Performance Chart—15°

PSI	Radius	GPM	Radius	GPM	Radius	GPM	Radius	GPM	Radius	GPM	Radius	GPM	Radius	GPM	Radius	GPM	Radius	GPM
50	43	8.2	52	13.6	58	18.1	61	21.5	62	25.6	—	—	—	—	—	—	—	—
65	45	10.0	54	15.3	60	20.3	64	24.2	65	27.3	69	33.1	—	—	—	—	—	—
80	46	11.5	58	17.2	64	22.6	69	26.8	69	30.2	75	36.8	76	39.7	76	42.9	76	42.9
100	47	13.4	60	19.0	66	24.7	71	29.5	72	32.9	78	39.5	82	42.6	82	46.1	82	46.1
Stator	102-6929 Blue						102-1939 Yellow						102-1940 White					
Conversions	FLX35-3134												FLX35-3537					

FLX55 Performance Data—25° – (U.S.)

Front Nozzle Positions	Nozzle Set 51  (Yellow)		Nozzle Set 52  (Blue)		Nozzle Set 53  (Brown)		Nozzle Set 54  (Orange)		Nozzle Set 55  (Green)		Nozzle Set 56  (Gray)		Nozzle Set 57  (Black)		Nozzle Set 58  (Red)		Nozzle Set 59  (Beige)		
	102-6906		102-0726		102-6907		102-0728		102-6955		102-6935		102-6936		102-6909		102-4259		
																			
	102-5670	102-5671	102-5670	102-6884	102-5670	102-6884	102-5670	102-6884	102-5670	102-6885	102-6531	102-6885	102-6531	102-6885	102-6531	102-6885	102-6531	102-6885	102-6531
Back Nozzle Positions	 Red Plug 102-4335																		
PSI	Radius	GPM	Radius	GPM	Radius	GPM	Radius	GPM	Radius	GPM	Radius	GPM	Radius	GPM	Radius	GPM	Radius	GPM	
50	55	14.1	57	18.5	62	22.3	66	25.8	—	—	—	—	—	—	—	—	—	—	
65	57	15.8	60	20.9	65	25.1	69	28.7	73	35.9	—	—	—	—	—	—	—	—	
80	59	17.5	61	23.1	68	27.8	72	31.7	76	39.7	80	43.1	83	48.2	85	50.0	89	57.5	
100	61	19.3	63	25.3	71	30.3	75	34.5	80	43.5	83	49.0	88	51.5	90	53.9	92	61.3	

FLX55 Series Performance Chart—15°

PSI	Radius	GPM	Radius	GPM	Radius	GPM	Radius	GPM	Radius	GPM	Radius	GPM	Radius	GPM	Radius	GPM	Radius	GPM		
50	55	14.0	59	16.5	62	22.2	63	25.6	—	—	—	—	—	—	—	—	—	—		
65	56	15.6	62	20.7	65	25.0	66	28.5	75	35.3	—	—	—	—	—	—	—	—		
80	59	17.4	66	23.0	69	27.7	70	31.5	78	39.0	78	42.4	79	46.9	79	49.5	82	57.2		
100	60	19.2	68	25.1	71	30.2	72	34.3	80	41.9	81	47.2	83	52.1	83	53.4	85	60.8		
Stator	102-1939 Yellow						102-1940 White						102-1941 White							
Conversions	FLX55-5154												FLX55-5558						FLX55-59	

■ Not recommended at these pressures.
Toro recommends the use of a 1 1/4" swing joint at flows over 25-GPM. Sprinkler radius of throw per ASAE standard S398.1.
All sprinklers are equipped with the selectable pilot valve that allows settings at 50, 65, 80 and 100 psi.

FLX35 Nozzle Apex—(U.S.)

Pressure	Nozzle	Apex at 15°	Apex at 25°
65 PSI	31	6' @ 51'	13' @ 54'
	32	6' @ 51'	11' @ 64'
	33	7' @ 59'	13' @ 68'
	34	8' @ 63'	15' @ 74'
	35	9' @ 66'	15' @ 76'
80 PSI	36	8' @ 75'	18' @ 83'
	37	9' @ 74'	19' @ 82'

FLX55 Nozzle Apex—(U.S.)

Pressure	Nozzle	Apex at 15°	Apex at 25°
65 PSI	51	6' @ 51'	13' @ 54'
	52	6' @ 51'	11' @ 64'
	53	7' @ 59'	13' @ 68'
	54	8' @ 63'	15' @ 74'
	55	9' @ 66'	15' @ 76'
	56	8' @ 75'	18' @ 83'
80 PSI	57	9' @ 74'	19' @ 82'
	58	10' @ 82'	18' @ 87'
	59	11' @ 81'	21' @ 91'



FLEX800™ SERIES GOLF ROTORS FLX34/FLX54



The NEW FLEX34/54 are the full circle irrigation sprinklers in the FLEX800™ Series. They come with dual trajectory main nozzle that provides exceptional nozzle performance at the 25° standard angle position and great performance in windy applications at the 15° low angle position. And the consistency of the constant velocity full circle drive ensures even water application across the coverage area every time you water.

Features & Benefits

Dual Trajectory - 25° or 15°

Provides two selections for the main nozzle trajectory; the 25 degree setting provides maximum distance of throw and the 15 degree setting provides improved wind performance, radius reduction and obstacle avoidance.

Industries Largest Nozzle Selection

Nozzles from 15,8 – 30,5m (52' to 100') plus a wide assortment of back nozzles lets you put the precise amount of water exactly where you need it. All nozzles threaded in from front.

Stainless Steel Valve Seat

Eliminates body damage from rocks and debris. This indestructible stainless steel seat is molded to the body and virtually eliminates body replacements due to seat damage.

Optional Radius Reduction Screw

Allows for fine tuning the radius to exactly the distance you need. In combination with main nozzle sizing and trajectory adjustment the radius reduction screw can effectively reduce the sprinkler throw down to 9,1m (30').

Constant Velocity Full Circle Drive

Ensures consistent rotation speeds when matched with station run times for even water application across the coverage area every time you water.

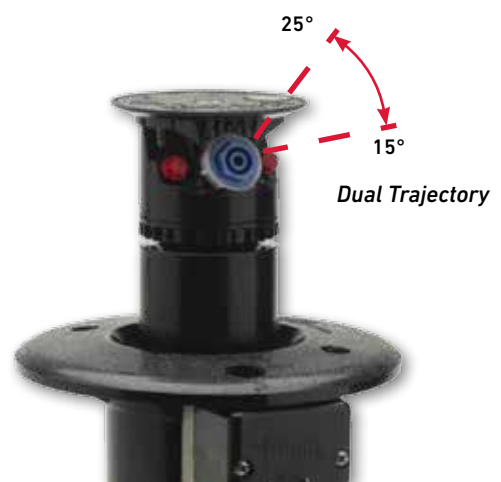



FLX34 Conversion Upgrades

Models	Description
• FLX34-3134	FLX34 w/31–34 Nozzles (#3 Nozzle)
• FLX34-3537	FLX34 w/35–37 Nozzles (#5 Nozzle)



FLX54 Conversion Upgrades

Models	Description
• FLX54-5154	FLX54 w/51–54 Nozzles (#3 Nozzle Installed)
• FLX54-5558	FLX54 w/55–58 Nozzles (#5 Nozzle)
• FLX54-59	FLX54 w/59 Nozzle



Features

- Dual Trajectory adjustment on main nozzle - 25° or 15°
- Full circle sprinklers
- Pop-up height to nozzle: 8,3cm (3.25")

Operating Specifications

Inlet

- FLX34: 25mm (1") ACME
- FLX54: 40mm (1.5") ACME

Radius

- FLX34: 15,8 – 27,7m (52' – 91')
- FLX54: 15,8 – 30,2m (52' – 99')

Flow Rate:

- FLX34: 48,8 - 177,5 LPM (13.0 – 46.9 GPM)
- FLX54: 50 - 233,9 LPM (13.2 – 61.8 GPM)

Precipitation Rates:

- FLX34: Minimum - 8,4mm/hr (0.33"/hr); Maximum - 14mm/hr (0.55"/hr)
- FLX54: Minimum - 8,4mm/hr (0.33"/hr); Maximum 15,5mm/hr (0.61"/hr)

Pilot Valve:

- Selectable at 3,4; 4,5; 5,5; and 6,9 Bar (50, 65, 80,100 psi)

Recommended Operating Pressure Range:

- 4,5-6,9 Bar (65-100 psi)
- Maximum: 10,3 Bar (150 psi)
- Minimum: 2,8 Bar (40 psi)

Activation types – Electric Valve-in-Head:

- Standard Solenoid:
 - 24 VAC, 50/60 Hz
 - Inrush: 0.30 A
 - Holding 0.20 A
- Spike Guard Solenoid:
 - 24 VAC, 50/60 Hz
 - Inrush: 0.12 A
 - Holding 0.10 A
- Nickel-Plated Spike Guard Solenoid:
 - 24 VAC, 50/60 Hz
 - Inrush: 0.12 A
 - Holding 0.10 A
- DC Latching Solenoid (DCLS):
 - 12 VDC pulse or latching pulse
- Integrated GDC Module w/DCLS:
 - 12 VDC pulse or latching pulse

Nozzle Selection

- FLX34 has seven nozzle variation (31, 32, 33, 34, 35, 36 and 37)
- FLX54 has nine nozzle variations (51, 52, 53, 54, 55, 56, 57, 58 and 59)
- Three opposing nozzles, rotating stream pattern
- Two additional front nozzle positions

Dimensions

- Body diameter:
 - FLX34: 16,5cm (6.5")
 - FLX54: 19,1cm (7.5")
- Body height:
 - FLX34: 25,4cm (10")
 - FLX54: 28,9cm (11.375")
- Weight:
 - FLX34: 1,35kg (2.98 lbs.)
 - FLX54: 1,68kg (3.70 lbs.)

Warranty

- Two years; Five years when installed with Toro Swing Joints

Specifying Information—FLX34 & FLX54























FLXX4-XXX-X				
Body Inlet	Arc	Nozzle	Pressure Regulation*	Activation Type
FLXX	4	XX	X	X
3— 25mm (1") 5— 40mm (1.5")	4—Full Circle	FLX34—31, 32, 33, 34, 35, 36, 37 FLX54—51, 52, 53, 54, 55, 56, 57, 58, 59	6— 4,5 bar (65 psi) 8— 6,5 bar (80 psi) 1— 6,9 bar (100 psi)	1—Standard Solenoid 2—Spike Guard™ Solenoid 3—Nickel-plated Spike Guard Solenoid 4—DC Latching Solenoid (DCLS) 5—Integrated GDC Module w/DCLS
Example: When specifying a FLX34 Series Sprinkler with #34 nozzle, pressure regulation at 4,5 bar (65 psi), and Spike Guard™ Solenoid you would specify: FLX34-346-2				

* Electric models only. All sprinklers are equipped with the selectable pilot valve that allows settings at 3,4; 4,5; 5,5; and 6,9 Bar (50, 65, 80 and 100 psi). Note: Not all models available. Nickel-plated, corrosion-resistant models are available upon request.



FLEX800™ SERIES GOLF ROTORS FLX34/FLX54

























FLX34 Series Performance Chart—25° (Metric)

Front Nozzle Positions			Nozzle Set 31		Nozzle Set 32		Nozzle Set 33		Nozzle Set 34		Nozzle Set 35		Nozzle Set 36		Nozzle Set 37	
			 (Yellow) 102-0725	 (Blue) 102-7001	 (Brown) 102-0727	 (Orange) 102-7002	 (Green) 102-6908	 (Gray) 102-0730	 (Black) 102-4261							
 Red Plug 102-4335																
Back Nozzle Positions			 Yellow 102-6937	 Blue 102-2925	 Yellow 102-6937	 Orange 102-2926	 Yellow 102-6937	 Red 102-2928	 Yellow 102-6937	 Beige 102-2929	 Yellow 102-6937	 Beige 102-2929	 Yellow 102-6937	 Red 102-2928	 Yellow 102-6937	 Gray 102-6945
			Bar	kPa	kg/cm ²	Radius	LPM	Radius	LPM	Radius	LPM	Radius	LPM	Radius	LPM	Radius
3,4	340	3,47	17,4	49,2	17,7	58,7	19,5	82,9	20,7	92,4	—	—	—	—	—	—
4,5	450	4,59	17,7	55,3	18,3	68,1	20,7	92,4	22,0	106,4	23,2	121,9	—	—	—	—
5,5	550	5,61	18,3	61,3	19,2	77,6	22,0	101,8	23,2	117,7	24,4	134,7	25,3	144,6	25,9	157,1
6,9	690	7,04	18,9	67,8	20,1	88,6	22,9	112,8	24,1	132,1	25,6	148,8	26,8	164,3	27,8	177,5

FLX34 Series Performance Chart—15°

Bar	kPa	kg/cm ²	Radius	LPM	Radius	LPM	Radius	LPM	Radius	LPM	Radius	LPM	Radius	LPM	Radius	LPM
3,4	340	3,47	15,9	48,8	16,2	59,0	18,3	82,1	18,9	96,5	—	—	—	—	—	—
4,5	450	4,59	16,2	54,5	16,5	64,7	18,6	91,6	19,5	106,0	20,4	121,5	—	—	—	—
5,5	550	5,61	17,1	60,6	17,4	71,9	19,8	100,7	21,0	117,3	22,3	134,4	23,2	143,8	23,5	156,3
6,9	690	7,04	17,4	66,2	18,0	77,6	20,4	111,7	21,7	128,3	22,9	145,3	24,4	163,1	24,7	177,1
Stator							102-6929 Blue					102-1940 White				
Conversions							FLX34-3134					FLX34-3537				

FLX54 Series Performance Chart—25° (Metric)

Front Nozzle Positions			Nozzle Set 51		Nozzle Set 52		Nozzle Set 53		Nozzle Set 54		Nozzle Set 55		Nozzle Set 56		Nozzle Set 57		Nozzle Set 58		Nozzle Set 59	
			 (Yellow) 102-0725	 (Blue) 102-7001	 (Brown) 102-0727	 (Orange) 102-7002	 (Green) 102-6908	 (Gray) 102-0730	 (Black) 102-4261	 (Red) 102-4260	 (Beige) 102-4259									
 Red Plug 102-4335																				
Back Nozzle Positions			 Yellow 102-6937	 Blue 102-2925	 Yellow 102-6937	 Orange 102-2926	 Yellow 102-6937	 Red 102-2928	 Yellow 102-6937	 Beige 102-2929	 Yellow 102-6937	 Beige 102-2929	 Yellow 102-6937	 Red 102-6944	 Yellow 102-6937	 Gray 102-6945	 Yellow 102-6937	 Gray 102-6945	 Yellow 102-6937	 Gray 102-6945
			Bar	kPa	kg/cm ²	Radius	LPM	Radius	LPM	Radius	LPM	Radius	LPM	Radius	LPM	Radius	LPM	Radius	LPM	Radius
3,4	340	3,47	17,7	50,0	18,0	59,4	19,5	83,3	21,4	99,2	—	—	—	—	—	—	—	—	—	—
4,5	450	4,59	18,3	56,0	18,6	66,2	20,7	93,9	22,6	110,9	24,1	129,4	—	—	—	—	—	—	—	—
5,5	550	5,61	18,6	62,1	19,5	75,7	22,0	104,5	23,8	123,4	25,3	143,8	25,9	154,0	26,5	169,9	27,8	190,0	29,3	210,4
6,9	690	7,04	19,2	68,5	20,4	89,3	22,9	115,1	24,7	138,9	26,5	160,9	27,5	173,4	28,4	190,0	29,0	209,7	30,2	233,9

FLX54 Series Performance Chart—15°

Bar	kPa	kg/cm ²	Radius	LPM	Radius	LPM	Radius	LPM	Radius	LPM	Radius	LPM	Radius	LPM	Radius	LPM	Radius	LPM	Radius	LPM
3,4	340	3,47	15,9	50,0	16,2	59,8	18,6	83,3	19,8	98,4	—	—	—	—	—	—	—	—	—	—
4,5	450	4,59	16,2	56,0	16,5	65,9	19,2	93,9	20,4	110,5	21,0	129,1	—	—	—	—	—	—	—	—
5,5	550	5,61	17,1	62,1	17,7	73,4	20,7	104,5	22,0	123,0	22,9	143,1	24,1	152,9	24,7	168,8	25,9	188,9	26,5	209,3
6,9	690	7,04	17,7	68,5	18,3	79,9	21,7	115,1	22,9	137,8	24,1	160,1	25,6	172,2	26,5	188,9	27,1	208,6	28,7	232,8
Stator							102-6929 Blue					102-1940 White					102-1941 White			
Conversions							FLX54-5154					FLX54-5558					FLX54-59			

Not recommended at these pressures. Radius shown in meter.
Toro recommends the use of a 30mm swing joint at flows over 95-LPM. Sprinkler radius of throw per ASAE standard S398.1.
Actual site conditions must be considered when selecting the appropriate nozzle.
All sprinklers are equipped with the selectable pilot valve that allows settings at 3,4; 4,5; 5,5 and 6,9 Bar.

FLX34 Nozzle Apex—(Metric)

Pressure	Nozzle	Apex at 15°	Apex at 25°
4,5 bar	31	1,8 @ 15,6	4,0 @ 16,5
	32	1,8 @ 15,6	3,4 @ 19,5
	33	2,1 @ 18,0	4,0 @ 20,7
	34	2,4 @ 19,2	4,6 @ 22,6
	35	2,7 @ 20,1	4,6 @ 23,2
5,5 bar	36	2,4 @ 22,9	5,5 @ 25,3
	37	2,7 @ 22,6	5,8 @ 25,0

FLX54 Nozzle Apex—(Metric)

Pressure	Nozzle	Apex at 15°	Apex at 25°
4,5 Bar	51	1,8 @ 15,6	4,0 @ 16,5
	52	1,8 @ 15,6	3,4 @ 19,5
	53	2,1 @ 18,0	4,0 @ 20,7
	54	2,4 @ 19,2	4,6 @ 22,6
	55	2,7 @ 20,1	4,6 @ 23,2
5,5 Bar	56	2,4 @ 22,9	5,5 @ 25,3
	57	2,7 @ 22,6	5,8 @ 25,0
	58	3,0 @ 25,0	5,5 @ 26,5
	59	3,4 @ 24,7	6,4 @ 27,1



FLX34 Series Performance Chart—25° (U.S.)

Front Nozzle Positions	Nozzle Set 31 (Yellow) 102-0725		Nozzle Set 32 (Blue) 102-7001		Nozzle Set 33 (Brown) 102-0727		Nozzle Set 34 (Orange) 102-7002		Nozzle Set 35 (Green) 102-6908		Nozzle Set 36 (Gray) 102-0730		Nozzle Set 37 (Black) 102-4261	
	Red Plug 102-4335													
Back Nozzle Positions	Yellow 102-6937	Blue 102-2925	Yellow 102-6937	Orange 102-2926	Yellow 102-6937	Red 102-2928	Yellow 102-6937	Beige 102-2929	Yellow 102-6937	Beige 102-2929	Yellow 102-6937	Red 102-2928	Yellow 102-6937	Gray 102-6945
PSI	Radius	GPM	Radius	GPM	Radius	GPM	Radius	GPM	Radius	GPM	Radius	GPM	Radius	GPM
50	57	13.0	58	15.5	64	21.9	68	24.4	—	—	—	—	—	—
65	58	14.6	60	18.0	68	24.4	72	28.1	76	32.2	—	—	—	—
80	60	16.2	63	20.5	72	26.9	76	31.1	80	35.6	83	38.2	85	41.5
100	62	17.9	66	23.4	75	29.8	79	34.9	84	39.3	88	43.4	91	46.9

FLX34 Series Performance Chart—15°

psi	Radius	GPM	Radius	GPM	Radius	GPM	Radius	GPM	Radius	GPM	Radius	GPM	Radius	GPM
50	52	12.9	53	15.6	60	21.7	62	25.5	—	—	—	—	—	—
65	53	14.4	54	17.1	61	24.2	64	28.0	67	32.1	—	—	—	—
80	56	16.0	57	19.0	65	26.6	69	31.0	73	35.5	76	38.0	77	41.3
100	57	17.5	59	20.5	67	29.5	71	33.9	75	38.4	80	43.1	81	46.8
Stator	102-6929 Blue										102-1940 White			
Conversions	FLX34-3134										FLX34-3537			

FLX54 Series Performance Chart—25° (U.S.)

Front Nozzle Positions	Nozzle Set 51 (Yellow) 102-0725		Nozzle Set 52 (Blue) 102-7001		Nozzle Set 53 (Brown) 102-0727		Nozzle Set 54 (Orange) 102-7002		Nozzle Set 55 (Green) 102-6908		Nozzle Set 56 (Gray) 102-0730		Nozzle Set 57 (Black) 102-4261		Nozzle Set 58 (Red) 102-4260		Nozzle Set 59 (Beige) 102-4259	
	Red Plug 102-4335																	
Back Nozzle Positions	Yellow 102-6937	Blue 102-2925	Yellow 102-6937	Orange 102-2926	Yellow 102-6937	Red 102-2928	Yellow 102-6937	Beige 102-2929	Yellow 102-6937	Beige 102-2929	Yellow 102-6937	Red 102-6944	Yellow 102-6937	Gray 102-6945	Yellow 102-6937	Gray 102-6945	Yellow 102-6937	Gray 102-6945
PSI	Radius	GPM	Radius	GPM	Radius	GPM	Radius	GPM	Radius	GPM	Radius	GPM	Radius	GPM	Radius	GPM	Radius	GPM
50	58	13.2	59	15.7	64	22.0	70	26.2	—	—	—	—	—	—	—	—	—	—
65	60	14.8	61	17.5	68	24.8	74	29.3	79	34.2	—	—	—	—	—	—	—	—
80	61	16.4	64	20.0	72	27.6	78	32.6	83	38.0	85	40.7	87	44.9	91	50.2	96	55.6
100	63	18.1	67	23.6	75	30.4	81	36.7	87	42.5	90	45.8	93	50.2	95	55.4	99	61.8

FLX54 Series Performance Chart—15°

psi	Radius	GPM	Radius	GPM	Radius	GPM	Radius	GPM	Radius	GPM	Radius	GPM	Radius	GPM	Radius	GPM	Radius	GPM
50	52	13.2	53	15.8	61	22.0	65	26.0	—	—	—	—	—	—	—	—	—	—
65	53	14.8	54	17.4	63	24.8	67	29.2	69	34.1	—	—	—	—	—	—	—	—
80	56	16.4	58	19.4	68	27.6	72	32.5	75	37.8	79	40.4	81	44.6	85	49.9	87	55.3
100	58	18.1	60	21.1	71	30.4	75	36.4	79	42.3	84	45.5	87	49.9	89	55.1	94	61.5
Stator	102-6929 Blue										102-1940 White						102-1941 White	
Conversions	FLX54-5154										FLX54-5558						FLX54-59	

■ Not recommended at these pressures. Radius shown in feet.
 Toro recommends the use of a 1 1/4" swing joint at flows over 25-GPM. Sprinkler radius of throw per ASAE standard S398.1.
 Actual site conditions must be considered when selecting the appropriate nozzle.
 All sprinklers are equipped with the selectable pilot valve that allows settings at 50, 65, 80 and 100 psi.

FLX34 Nozzle Apex—(U.S.)

Pressure	Nozzle	Apex at 15°	Apex at 25°
65 PSI	31	6' @ 51'	13' @ 54'
	32	6' @ 51'	11' @ 64'
	33	7' @ 59'	13' @ 68'
	34	8' @ 63'	15' @ 74'
	35	9' @ 66'	15' @ 76'
80 PSI	36	8' @ 75'	18' @ 83'
	37	9' @ 74'	19' @ 82'

FLX54 Nozzle Apex—(U.S.)

Pressure	Nozzle	Apex at 15°	Apex at 25°
65 PSI	51	6' @ 51'	13' @ 54'
	52	6' @ 51'	11' @ 64'
	53	7' @ 59'	13' @ 68'
	54	8' @ 63'	15' @ 74'
	55	9' @ 66'	15' @ 76'
80 PSI	56	8' @ 75'	18' @ 83'
	57	9' @ 74'	19' @ 82'
	58	10' @ 82'	18' @ 87'
	59	11' @ 81'	21' @ 91'



FLEX800™ B SERIES GOLF ROTORS



The FLEX800™ B Series golf sprinkler family brings you all the great features and performance of the FLEX800 35-6, 34 and 35 Series sprinklers in a more economical body package specifically designed for block systems. With its rugged golf body design, small exposed surface diameter, flanged body for stability and check valve these sprinklers are perfect for every golf application.

Features & Benefits

Industries Largest Nozzle Selection

Nozzles from 7,6 – 29,0m (25' to 95') radius, plus a wide assortment of intermediate and inner nozzles, provide unmatched flexibility allowing you to put the precise amount of water exactly where you need it. All nozzles threaded in from front.

True Part Full-Circle in One – (40° - 330° part circle)

These sprinklers can be full circle or part circle allowing you to adjust the area of coverage to match your seasonal needs or meet water rationing mandates.

Flanged Cap Installs Below Grade

Stabilizes the body position and maintains optimum nozzle performance.

Small Exposed Diameter

Minimizes the appearance of the sprinkler to maximize the beauty of the course. Perfect for high traffic areas like tees, greens and surrounds.





Nozzle Trajectory Provides Unmatched Performance
FLX35-6B with TruJectory™ adjustment from 7°-30° in 1° increments and FLX35/FLX34 models with dual trajectory settings of 25° or 15° provide improved wind performance, obstacle avoidance and radius adjustment.



FLX35-6B

FLX34B and FLX35B



Main Nozzle Adapter
A wide assortment of intermediate and inner nozzles for use in the main nozzle adapter and back nozzle position provide unmatched nozzle flexibility.



Features

- Ratcheting riser
- Nozzle base clutching – Part circle models

Operating Specifications

- Inlet:
 - 25mm (1") NPT, BSP or ACME
- Radius:
 - FLX35-6B: 9m – 29m (29' – 95')
 - FLX35B: 9m – 27m (29' – 90')
 - FLX34B: 17m – 29m (57' – 95')
- Flow Rate:
 - FLX35-6B: 26,8 – 198,7 LPM (7.1 – 52.5 gpm)
 - FLX35B: 31,0 – 213,1 LPM (8.2 – 56.3 gpm)
 - FLX34B: 49,2 – 209,7 LPM (13.0 – 55.4 gpm)
- Precipitation Rates:
 - FLX35-6B: 8,6 – 14,2 mm/hr (0.34 in/hr – 0.56 in/hr)
 - FLX35B: 9,3 – 17,0 mm/hr (0.37 in/hr – 0.67 in/hr)
 - FLX34B: 8,3 – 14,9 mm/hr (0.33 in/hr – 0.59 in/hr)
- Recommended Operating Pressure
 - 4,4 – 6,9 Bar (65-100 psi)
- Trajectory:
 - FLX35-6B – 7°-30° in 1° increments; 24 positions
 - FLX35B – 15° or 25° – 2 positions
 - FLX34B – 15° or 25° – 2 positions
- Check-O-Matic feature prevents low head drainage up to 10' of elevation change

Nozzle Selection

- Nozzle variations
 - FLX35-6B – Nine variations (30, 31, 32, 33, 34, 35, 36, 37 & 38)
 - FLX35B – Nine variations (30, 31, 32, 33, 34, 35, 36, 37 & 38)
 - FLX34B – Eight variations (31, 32, 33, 34, 35, 36, 37 & 38)
- Back nozzle capability on part circle models standard
 - FLX35-6B – one position available
 - FLX35B – two positions available
- FLX34B – two additional front nozzle positions
- Main-less capability for short radius applications
- Stator variations:
 - FLX35-6B, FLX35: 3
 - FLX34: 2
- Radius reduction screw for fine tuning the radius (363-4839). Standard on FLX35B; optional on FLX34B and not available on FLX35-6B models

Dimensions

- Body diameter: 15,2cm (6")
- Body height: 21,6cm (8.5")
- Weight:
 - FLX35-6B: 0,9kg (1.99 lbs)
 - FLX35B: 0,9kg (2 lbs)
 - FLX34B: 0,89kg (1.97 lbs)
- Pop-up height to nozzle: 8,25cm (3.25")

Warranty

- Two years; Five years when installed with Toro Swing Joints

Specifying Information – B Series

FLX3XB-X2-XXXX					
Series	Arc	System	Thread Type	Valve Type	Nozzle
FLX3	X	B	X	2	XXXX
FLX3—FLEX800 B Series	4—Full-Circle (DT only) 5—Part-/Full-Circle 5-6--Part-/Full-Circle with TruJectory	B—Block	0—NPT 4—ACME 5—BSP	Check-O-Matic	3134—Includes nozzles #31, 32, 33 & 34 3538—Includes nozzles #35, 36, 37 & 38

Example: When specifying a FLEX800 B Series Sprinkler with full circle - NPT threads, #34 nozzle, you would specify: FLX34B-02-3134



FLEX800™ B SERIES GOLF ROTORS

FLX35-6B Series Performance Chart—25° (Metric)

Base Pressure			Nozzle Set 30		Nozzle Set 31		Nozzle Set 32		Nozzle Set 33		Nozzle Set 34		Nozzle Set 35		Nozzle Set 36		Nozzle Set 37		Nozzle Set 38	
			(White) 102-2208		(Yellow) 102-4587		(Blue) 102-4588		(Brown) 102-4589		(Orange) 102-0728		(Green) 102-0729		(Gray) 102-0730		(Black) 102-4261		(Red) 102-6909	
			Blue	Gray	Blue	Gray	Red	Gray	Orange	Gray	Orange	Gray	Blue	Gray	Blue	Gray	Orange	Gray	Blue	Gray
			102-2925	102-2910	102-2925	102-2910	102-2928	102-2910	102-2926	102-2910	102-2926	102-2910	102-2925	102-2910	102-2925	102-2910	102-2926	102-2910	102-2925	102-2910
Back Nozzle 102-4335 Red Plug																				
Bar	kPa	kg/cm ²	Radius	LPM	Radius	LPM	Radius	LPM	Radius	LPM	Radius	LPM	Radius	LPM	Radius	LPM	Radius	LPM	Radius	LPM
3,5	345	3,52	13	26,9	16	53,0	18	68,1	—	—	—	—	—	—	—	—	—	—	—	—
4,1	414	4,22	13	30,0	16	57,5	18	73,9	20	82,9	—	—	—	—	—	—	—	—	—	—
4,8	483	4,92	14	33,1	17	62,1	19	79,6	21	89,3	23	123,8	23	133,2	—	—	—	—	—	—
5,5	552	5,63	14	36,3	17	65,9	20	85,5	21	95,8	23	132,9	24	142,7	26	149,9	26	164,3	27	179,8
6,2	621	6,33	14	39,4	18	70,0	21	90,5	22	101,2	24	140,0	25	151,0	26	158,6	27	173,7	28	189,3
6,9	689	7,03	15	42,4	18	73,4	21	95,4	23	106,7	24	147,2	26	158,2	27	166,9	27	183,2	29	198,7
Stator			102-6929 Blue						102-1939 Yellow						102-1940 White					
Conversions			INF35-6-3134 (Requires screen replacement)												INF35-6-3537 (Requires screen replacement)					

FLX35B Series Performance Chart—25° (Metric)

Front Nozzle Positions			Nozzle Set 30		Nozzle Set 31		Nozzle Set 32		Nozzle Set 33		Nozzle Set 34		Nozzle Set 35		Nozzle Set 36		Nozzle Set 37		Nozzle Set 38	
			(White Plug) 102-2208		(Yellow) 102-6906		(Blue) 102-0726		(Brown) 102-6907		(Orange) 102-0728		(Green) 102-6955		(Gray) 102-6935		(Black) 102-6936		(Red) 102-6909	
			Yellow	Beige	Yellow	Brown	Yellow	Yellow	Yellow	Yellow	Yellow	Yellow	Yellow	Green	Green	Green	Green	Green	Green	Green
			102-5670	102-6942	102-5670	102-5671	102-5670	102-6884	102-5670	102-6884	102-5670	102-6884	102-5670	102-6885	102-6531	102-6885	102-6531	102-6885	102-6531	102-6885
Back Nozzles 102-4335 Red Plug																				
Bar	kPa	kg/cm ²	rad/m	lpm	rad/m	lpm	rad/m	lpm	rad/m	lpm	rad/m	lpm	rad/m	lpm	rad/m	lpm	rad/m	lpm	rad/m	lpm
3,5	345	3,52	13	31,0	17	51,5	17	69,3	—	—	—	—	—	—	—	—	—	—	—	—
4,1	414	4,22	13	35,2	17	56,8	18	76,1	19	91,6	—	—	—	—	—	—	—	—	—	—
4,8	483	4,92	14	39,3	18	61,3	18	82,5	20	99,5	21	113,6	22	140,0	—	—	—	—	—	—
5,5	552	5,63	14	43,5	18	65,5	19	88,2	20	106,0	22	121,5	23	149,9	24	162,4	24	184,0	26	191,5
6,2	621	6,33	14	47,1	18	69,6	19	93,5	21	112,8	22	129,4	23	159,0	24	171,8	25	194,9	27	202,9
6,9	689	7,03	14	50,7	19	73,1	20	98,4	21	118,8	23	135,9	24	167,3	25	184,7	25	205,1	27	213,1
Stator			102-6929 Blue						102-1939 Yellow						102-1940 White					
Conversions			FLX35-3134 (Requires screen replacement)												FLX35-3537 (Requires screen replacement)					

FLX34B Series Performance Chart—25° (Metric)

Front Nozzle Positions			Nozzle Set 31		Nozzle Set 32		Nozzle Set 33		Nozzle Set 34		Nozzle Set 35		Nozzle Set 36		Nozzle Set 37		Nozzle Set 38			
			(Yellow) 102-0725		(Blue) 102-7001		(Brown) 102-0727		(Orange) 102-7002		(Green) 102-6908		(Gray) 102-0730		(Black) 102-4261		(Red) 102-4260			
			Yellow	Blue	Yellow	Orange	Yellow	Red	Yellow	Beige	Yellow	Beige	Yellow	Red	Yellow	Gray	Yellow	Gray		
			102-6937	102-2925	102-6937	102-2926	102-6937	102-2928	102-6937	102-2929	102-6937	102-2929	102-6937	102-6944	102-6937	102-6945	102-6937	102-6945		
Front Nozzles 102-4335 Red Plug																				
Bar	kPa	kg/cm ²	rad/m	lpm	rad/m	lpm	rad/m	lpm	rad/m	lpm	rad/m	lpm	rad/m	lpm	rad/m	lpm	rad/m	lpm		
3,5	345	3,52	17	49,2	18	58,7	—	—	—	—	—	—	—	—	—	—	—	—		
4,1	414	4,22	18	53,2	18	64,9	20	89,3	—	—	—	—	—	—	—	—	—	—		
4,8	483	4,92	18	58,7	19	68,9	21	99,2	22	113,6	24	135,1	—	—	—	—	—	—		
5,5	552	5,63	18	61,3	19	77,6	22	105,6	23	121,5	24	144,6	25	154,8	26	159,3	28	190,0		
6,2	621	6,33	19	66,2	20	83,1	22	112,2	24	128,9	25	153,1	26	164,1	27	168,4	28	199,8		
6,9	689	7,03	19	71,2	20	88,6	23	118,8	24	136,3	26	161,6	27	173,4	28	177,5	29	209,7		
Stator			102-6929 Blue						102-1940 White											
Conversions			FLX34-3134 (Requires screen replacement)												FLX34-3537 (Requires screen replacement)					

■ Not recommended at these pressures. Radius shown in meter.
 Toro recommends the use of a 30mm swing joint at flows over 95-LPM. Sprinkler radius data collected in Toro's zero wind test facility per ASAE standard S398.1.
 Actual site conditions must be considered when selecting the appropriate nozzle.

All sprinklers are equipped with the selectable pilot valve that allows settings at 3,4; 4,5; 5,5; and 6,9 Bar.



FLX35-6B Series Performance Chart—25° (U.S.)

Base Pressure	Nozzle Set 30 (White) 102-2208		Nozzle Set 31 (Yellow) 102-4587		Nozzle Set 32 (Blue) 102-4588		Nozzle Set 33 (Brown) 102-4589		Nozzle Set 34 (Orange) 102-0728		Nozzle Set 35 (Green) 102-0729		Nozzle Set 36 (Gray) 102-0730		Nozzle Set 37 (Black) 102-4261		Nozzle Set 38 (Red) 102-6909	
	Blue	Gray	Blue	Gray	Red	Gray	Orange	Gray	Orange	Gray	Blue	Gray	Blue	Gray	Orange	Gray	Blue	Gray
	102-2925	102-2910	102-2925	102-2910	102-2928	102-2910	102-2926	102-2910	102-2926	102-2910	102-2925	102-2910	102-2925	102-2910	102-2926	102-2910	102-2925	102-2910
Back Nozzle 102-4335																		
PSI	Radius	GPM	Radius	GPM	Radius	GPM	Radius	GPM	Radius	GPM	Radius	GPM	Radius	GPM	Radius	GPM	Radius	GPM
50	42	7.1	52	14.0	58	18.0	—	—	—	—	—	—	—	—	—	—	—	—
60	43	7.9	54	15.2	60	19.5	66	21.9	—	—	—	—	—	—	—	—	—	—
70	45	8.8	55	16.4	63	21.0	68	23.6	74	32.7	77	35.2	—	—	—	—	—	—
80	46	9.6	57	17.4	65	22.6	70	25.3	77	35.1	79	37.7	84	39.6	86	43.4	90	47.5
90	47	10.4	58	18.5	68	23.9	72	26.8	79	37.0	82	39.9	86	41.9	88	45.9	93	50.0
100	48	11.2	59	19.4	70	25.2	74	28.2	80	38.9	84	41.8	88	44.1	90	48.4	95	52.5
Stator	102-6929 Blue		102-1939 Yellow								102-1940 White							
Conversions	INF35-6-3134 (Requires screen replacement)								INF35-6-3537 (Requires screen replacement)									

FLX35B Series Performance Chart—25° (U.S.)

Front Nozzle Positions	Nozzle Set 30 (White Plug) 102-2208		Nozzle Set 31 (Yellow) 102-6906		Nozzle Set 32 (Blue) 102-0726		Nozzle Set 33 (Brown) 102-6907		Nozzle Set 34 (Orange) 102-0728		Nozzle Set 35 (Green) 102-6955		Nozzle Set 36 (Gray) 102-6935		Nozzle Set 37 (Black) 102-6936		Nozzle Set 38 (Red) 102-6909	
	Yellow	Beige	Yellow	Brown	Yellow	Yellow	Yellow	Yellow	Yellow	Yellow	Yellow	Green	Green	Green	Green	Green	Green	Green
	102-5670	102-6942	102-5670	102-5671	102-5670	102-6884	102-5670	102-6884	102-5670	102-6884	102-5670	102-6885	102-6531	102-6885	102-6531	102-6885	102-6531	102-6885
Back Nozzles 102-4335																		
PSI	Radius	GPM	Radius	GPM	Radius	GPM	Radius	GPM	Radius	GPM	Radius	GPM	Radius	GPM	Radius	GPM	Radius	GPM
50	43	8.2	55	13.6	56	18.3	—	—	—	—	—	—	—	—	—	—	—	—
60	44	9.3	56	15.0	58	20.1	63	24.2	—	—	—	—	—	—	—	—	—	—
70	45	10.4	58	16.2	60	21.8	65	26.3	69	30.0	73	37.0	—	—	—	—	—	—
80	46	11.5	59	17.3	62	23.3	67	28.0	71	32.1	75	39.6	78	42.9	80	48.6	85	50.6
90	47	12.5	60	18.4	64	24.7	69	29.8	73	34.2	77	42.0	80	45.4	82	51.5	88	53.6
100	47	13.4	61	19.3	65	26.0	70	31.4	74	35.9	79	44.2	81	48.8	83	54.2	90	56.3
Stator	102-6929 Blue		102-1939 Yellow								102-1940 White							
Conversions	FLX35-3134 (Requires screen replacement)								FLX35-3537 (Requires screen replacement)									

FLX34B Series Performance Chart—25° (U.S.)

Front Nozzle Positions	Nozzle Set 31 (Yellow) 102-0725		Nozzle Set 32 (Blue) 102-7001		Nozzle Set 33 (Brown) 102-0727		Nozzle Set 34 (Orange) 102-7002		Nozzle Set 35 (Green) 102-6908		Nozzle Set 36 (Gray) 102-0730		Nozzle Set 37 (Black) 102-4261		Nozzle Set 38 (Red) 102-4260	
	Yellow	Blue	Yellow	Orange	Yellow	Red	Yellow	Beige	Yellow	Beige	Yellow	Red	Yellow	Gray	Yellow	Gray
	102-6937	102-2925	102-6937	102-2926	102-6937	102-2928	102-6937	102-2929	102-6937	102-2929	102-6937	102-6944	102-6937	102-6945	102-6937	102-6945
Front Nozzles 102-4335																
PSI	Radius	GPM	Radius	GPM	Radius	GPM	Radius	GPM	Radius	GPM	Radius	GPM	Radius	GPM	Radius	GPM
50	57	13.0	58	15.5	—	—	—	—	—	—	—	—	—	—	—	—
60	58	14.1	60	17.2	67	23.6	—	—	—	—	—	—	—	—	—	—
70	59	15.5	61	18.2	69	26.2	73	30.0	78	35.7	—	—	—	—	—	—
80	60	16.2	63	20.5	72	27.9	76	32.1	80	38.2	83	40.9	85	42.1	91	50.2
90	61	17.5	65	22.0	74	29.7	78	34.1	82	40.5	86	43.4	88	44.5	93	52.8
100	62	18.8	66	23.4	75	31.4	79	36.0	84	42.7	88	45.8	91	46.9	95	55.4
Stator	102-6929 Blue								102-1940 White							
Conversions	FLX34-3134 (Requires screen replacement)								FLX34-3537 (Requires screen replacement)							

■ Not recommended at these pressures. Radius shown in feet.

Toro recommends the use of a 1.25" swing joint at flows over 25-GPM. Sprinkler radius data collected in Toro's zero wind test facility per ASAE standard S398.1. Actual site conditions must be considered when selecting the appropriate nozzle.

All sprinklers are equipped with the selectable pilot valve that allows settings at 50, 65, 80 and 100 psi.



Intermediate Nozzle Performance Charts

102-2929 Beige		Trajectory		30°		25°		20°		15°		10°		7°	
Pressure		Flow		Radius		Radius		Radius		Radius		Radius		Radius	
PSI	BAR	LPM	GPM	Meters	Feet	Meters	Feet	Meters	Feet	Meters	Feet	Meters	Feet	Meters	Feet
50	3,4	30,7	8.1	17.4	53	17.1	52	16.4	50	15.7	48	14.8	45	13.8	42
60	4,1	33,7	8.9	18.7	57	18.4	56	17.4	53	16.7	51	15.4	47	14.8	45
65	4,5	35,2	9.3	19.0	58	18.4	56	17.7	54	16.7	51	16.1	49	15.1	46
70	4,8	36,3	9.6	19.4	59	18.7	57	18.4	56	17.4	53	16.4	50	15.7	48
80	5,5	39,0	10.3	20.0	61	19.7	60	19.0	58	18.4	56	17.4	53	16.4	50
90	6,2	41,3	10.9	20.7	63	20.0	61	19.4	59	18.7	57	17.7	54	16.7	51
100	6,9	43,5	11.5	21.3	65	20.7	63	19.7	60	19.0	58	18.0	55	16.7	51

102-2928 Red		Trajectory		30°		25°		20°		15°		10°		7°	
Pressure		Flow		Radius		Radius		Radius		Radius		Radius		Radius	
PSI	BAR	LPM	GPM	Meters	Feet	Meters	Feet	Meters	Feet	Meters	Feet	Meters	Feet	Meters	Feet
50	3,4	23,8	6.3	17.4	53	16.7	51	15.7	48	15.1	46	14.1	43	13.1	40
60	4,1	26,5	7.0	18.0	55	17.4	53	16.4	50	15.7	48	14.8	45	13.8	42
65	4,5	27,3	7.2	18.4	56	17.7	54	17.1	52	16.1	49	15.4	47	14.4	44
70	4,8	28,4	7.5	18.7	57	18.0	55	17.4	53	16.7	51	16.1	49	15.1	46
80	5,5	30,3	8.0	19.4	59	19.0	58	18.4	56	17.7	54	17.1	52	16.1	49
90	6,2	32,2	8.5	19.7	60	19.0	58	18.7	57	18.0	55	17.4	53	16.4	50
100	6,9	34,1	9.0	20.0	61	19.4	59	18.7	57	18.0	55	17.4	53	16.4	50

102-2927 Gray		Trajectory		30°		25°		20°		15°		10°		7°	
Pressure		Flow		Radius		Radius		Radius		Radius		Radius		Radius	
PSI	BAR	LPM	GPM	Meters	Feet	Meters	Feet	Meters	Feet	Meters	Feet	Meters	Feet	Meters	Feet
50	3,4	18,9	5.0	16.4	50	15.7	48	15.1	46	14.4	44	13.5	41	12.5	38
60	4,1	20,8	5.5	17.1	52	16.4	50	15.7	48	15.1	46	14.1	43	13.1	40
65	4,5	21,6	5.7	17.4	53	16.7	51	16.1	49	15.1	46	14.4	44	13.5	41
70	4,8	22,3	5.9	17.4	53	16.7	51	16.1	49	15.4	47	14.8	45	13.8	42
80	5,5	23,8	6.3	17.7	54	17.1	52	16.4	50	15.7	48	15.1	46	14.1	43
90	6,2	25,4	6.7	18.0	55	17.4	53	17.1	52	16.4	50	15.7	48	14.8	45
100	6,9	26,9	7.1	18.0	55	17.7	54	17.4	53	17.1	52	16.4	50	15.1	46

102-2926 Orange		Trajectory		30°		25°		20°		15°		10°		7°	
Pressure		Flow		Radius		Radius		Radius		Radius		Radius		Radius	
PSI	BAR	LPM	GPM	Meters	Feet	Meters	Feet	Meters	Feet	Meters	Feet	Meters	Feet	Meters	Feet
50	3,4	16,3	4.3	15.7	48	15.1	46	14.4	44	13.8	42	12.8	39	11.5	35
60	4,1	17,8	4.7	16.4	50	15.7	48	15.1	46	14.4	44	13.5	41	12.5	38
65	4,5	18,5	4.9	16.7	51	16.1	49	15.4	47	14.8	45	13.8	42	12.8	39
70	4,8	19,3	5.1	16.7	51	16.4	50	15.7	48	15.1	46	14.1	43	13.1	40
80	5,5	20,4	5.4	17.1	52	16.7	51	16.4	50	15.7	48	14.8	45	13.8	42
90	6,2	22,0	5.8	17.4	53	17.1	52	16.7	51	16.1	49	15.4	47	14.4	44
100	6,9	23,1	6.1	17.7	54	17.4	53	17.1	52	16.4	50	15.7	48	14.8	45

102-2925 Blue		Trajectory		30°		25°		20°		15°		10°		7°	
Pressure		Flow		Radius		Radius		Radius		Radius		Radius		Radius	
PSI	BAR	LPM	GPM	Meters	Feet	Meters	Feet	Meters	Feet	Meters	Feet	Meters	Feet	Meters	Feet
50	3,4	10,2	2.7	13.8	42	13.5	41	12.8	39	12.5	38	11.8	36	11.2	34
60	4,1	11,4	3.0	14.1	43	13.8	42	13.1	40	12.8	39	12.1	37	11.5	35
65	4,5	12,1	3.2	14.1	43	13.8	42	13.1	40	12.8	39	12.1	37	11.5	35
70	4,8	12,5	3.3	14.4	44	13.8	42	13.5	41	12.8	39	12.5	38	11.8	36
80	5,5	13,2	3.5	14.4	44	14.1	43	13.5	41	13.1	40	12.5	38	11.8	36
90	6,2	14,0	3.7	14.8	45	14.4	44	13.8	42	13.5	41	12.8	39	12.1	37
100	6,9	14,8	3.9	14.8	45	14.4	44	14.1	43	13.8	42	13.1	40	12.5	38



102-6885 Green		Trajectory		30°		25°		20°		15°		10°		7°	
Pressure		Flow		Radius		Radius		Radius		Radius		Radius		Radius	
PSI	BAR	LPM	GPM	Meters	Feet	Meters	Feet	Meters	Feet	Meters	Feet	Meters	Feet	Meters	Feet
50	3,4	20,4	5.4	16.7	51	16.4	50	15.7	48	14.8	45	13.8	42	12.8	39
60	4,1	22,3	5.9	17.1	52	16.7	51	16.1	49	15.1	46	14.1	43	13.5	41
65	4,5	23,1	6.1	17.1	52	16.7	51	16.4	50	15.4	47	14.4	44	13.8	42
70	4,8	23,8	6.3	17.4	53	17.1	52	16.4	50	15.4	47	14.4	44	13.8	42
80	5,5	25,4	6.7	17.4	53	17.1	52	16.7	51	15.7	48	14.8	45	14.1	43
90	6,2	26,9	7.1	17.7	54	17.4	53	17.1	52	16.4	50	15.4	47	14.8	45
100	6,9	28,0	7.4	18.0	55	18.0	55	17.7	54	17.1	52	16.1	49	15.4	47

102-6884 Yellow		Trajectory		30°		25°		20°		15°		10°		7°	
Pressure		Flow		Radius		Radius		Radius		Radius		Radius		Radius	
PSI	BAR	LPM	GPM	Meters	Feet	Meters	Feet	Meters	Feet	Meters	Feet	Meters	Feet	Meters	Feet
50	3,4	15,5	4.1	15.7	48	15.4	47	14.8	45	13.5	41	12.5	38	11.5	35
60	4,1	17,0	4.5	16.1	49	15.7	48	15.4	47	14.4	44	13.5	41	12.5	38
65	4,5	17,8	4.7	16.4	50	16.1	49	15.7	48	14.8	45	13.8	42	12.8	39
70	4,8	18,2	4.8	16.4	50	16.1	49	15.7	48	14.8	45	14.1	43	13.1	40
80	5,5	19,3	5.1	16.7	51	16.4	50	16.1	49	15.4	47	14.4	44	13.5	41
90	6,2	20,4	5.4	17.4	53	17.1	52	16.4	50	15.7	48	14.8	45	13.8	42
100	6,9	22,0	5.8	17.7	54	17.4	53	16.7	51	16.1	49	15.1	46	14.1	43

102-6883 Brown		Trajectory		30°		25°		20°		15°		10°		7°	
Pressure		Flow		Radius		Radius		Radius		Radius		Radius		Radius	
PSI	BAR	LPM	GPM	Meters	Feet	Meters	Feet	Meters	Feet	Meters	Feet	Meters	Feet	Meters	Feet
50	3,4	9,1	2.4	13.5	41	13.1	40	12.5	38	11.8	36	10.8	33	9.8	30
60	4,1	9,8	2.6	14.1	43	13.8	42	13.1	40	12.5	38	11.8	36	10.8	33
65	4,5	10,2	2.7	14.4	44	13.8	42	13.5	41	12.8	39	12.1	37	11.2	34
70	4,8	10,6	2.8	14.8	45	14.1	43	13.8	42	13.1	40	12.5	38	11.5	35
80	5,5	11,4	3.0	15.1	46	14.8	45	14.1	43	13.5	41	13.1	40	11.8	36
90	6,2	12,1	3.2	15.1	46	14.8	45	14.4	44	13.8	42	13.5	41	12.1	37
100	6,9	12,9	3.4	15.1	46	14.8	45	14.4	44	14.1	43	13.5	41	12.5	38

Inner Nozzle Performance Charts*

102-6937 Yellow		Trajectory		30°		25°		20°	
Pressure		Flow		Radius		Radius		Radius	
PSI	BAR	LPM	GPM	Meters	Feet	Meters	Feet	Meters	Feet
50	3,4	14,0	3.7	8.5	26	7.9	24	6.6	20
60	4,1	15,1	4.0	9.2	28	8.2	25	7.2	22
65	4,5	15,9	4.2	9.2	28	8.2	25	7.2	22
70	4,8	16,7	4.4	9.2	28	8.5	26	7.5	23
80	5,5	17,8	4.7	9.2	28	8.5	26	7.9	24
90	6,2	18,9	5.0	9.5	29	8.9	27	8.2	25
100	6,9	19,7	5.2	9.8	30	9.5	29	8.9	27

102-6531 Green		Trajectory		30°		25°		20°	
Pressure		Flow		Radius		Radius		Radius	
PSI	BAR	LPM	GPM	Meters	Feet	Meters	Feet	Meters	Feet
50	3,4	15,1	4.0	10.5	32	9.8	30	8.5	26
60	4,1	16,3	4.3	11.2	34	10.2	31	8.9	27
65	4,5	17,0	4.5	11.2	34	10.2	31	8.9	27
70	4,8	17,8	4.7	11.2	34	10.2	31	9.2	28
80	5,5	18,9	5.0	11.2	34	10.5	32	9.5	29
90	6,2	20,1	5.3	11.2	34	10.5	32	9.5	29
100	6,9	21,2	5.6	11.5	35	10.8	33	9.8	30



* Not recommended below 20°



Back Nozzle Data

Back Nozzle Performance Data—(Metric)

Nozzles			4,5 Bar 448 kPa 4,6 kg/cm2	5,5 Bar 552 kPa 5,6 kg/cm2			
Part #	Description	Color	Radius - m	LPM	Radius - m	LPM	Profile
102-6937	Inner Nozzle with Yellow Restrictor	Yellow/White	8,8	14,0	9,2	15,5	
102-6531	Inner Nozzle with White Restrictor	Green/White	9,5	16,3	10,1	17,4	
102-2135	Inner Nozzle with White Restrictor	White/White	7,6	15,5	7,9	17,0	
102-2136	Inner nozzle assy w/ yel restrictor	Yellow/White	7,3	14,4	7,6	15,5	
102-6883	Intermediate Nozzle	Brown	11,6	10,6	11,6	10,6	
102-6884	Intermediate Nozzle	Yellow	12,5	15,5	13,1	17,0	
102-6885	Intermediate Nozzle	Green	12,8	20,4	13,7	22,7	
102-2925	Intermediate Nozzle	Blue	12,2	10,6	12,8	12,1	
102-2926	Intermediate Nozzle	Orange	13,4	16,3	13,7	18,2	
102-2927	Intermediate Nozzle	Gray	14,0	19,3	14,3	20,4	
102-2928	Intermediate Nozzle	Red	14,6	24,6	15,3	26,5	
102-2929	Intermediate Nozzle	Beige	15,6	30,7	16,2	34,4	

Back Nozzle Performance Data—(U.S.)

Nozzles			65 PSI		80 PSI		
Part #	Description	Color	Radius	GPM	Radius	GPM	Profile
102-6937	Inner Nozzle w/ Yellow Restrictor	Yellow/White	29	3.7	30	4.1	
102-6531	Inner Nozzle w/ White Restrictor	Green/White	31	4.3	33	4.6	
102-6883	Intermediate Nozzle	Brown	38	2.8	38	2.8	
102-6884	Intermediate Nozzle	Yellow	41	4.1	43	4.5	
102-6885	Intermediate Nozzle	Green	42	5.4	45	6.0	
102-2925	Intermediate Nozzle	Blue	40	2.8	42	3.2	
102-2926	Intermediate Nozzle	Orange	44	4.3	45	4.8	
102-2927	Intermediate Nozzle	Gray	46	5.1	47	5.4	
102-2928	Intermediate Nozzle	Red	48	6.5	50	7.0	
102-2929	Intermediate Nozzle	Beige	51	8.1	53	9.1	



Toro is always there to help you care for your landscapes the way you want,
when you want, better than anyone else.

www.toro.com

Worldwide Headquarters
The Toro Company
8111 Lyndale Ave. So.
Bloomington, MN 55420 U.S.A.
Phone: (1) 952 888 8801
Fax: (1) 952 887 8258

Printed in U.S.A.
©2014 The Toro Company.
All Rights Reserved.

GB 200-6099



Count on it.



facebook.com/toro.yard
twitter.com/TheToroCompany
youtube.com/ToroCompanyEurope

Products depicted in this literature are for demonstration purposes only. Actual products offered for sale may vary in use, design, required attachments and safety features. We reserve the right to improve our products and make changes in specifications, design and standard equipment without notice and without incurring obligation. See your dealer for details on all our warranties.